



Magnetic Autocontrol GmbH

Grienmatt 20
D-79650 Schopfheim
Tel. 07622 695-5

Job number 5526,0087

Type BAT010C

MHTM - MicroDrive - ACCESS/PRO - R/L C... 0 0

Number of pages 7

				15.08.2014
02	03.07.15	5K15503	gp	gp
01	23.09.14	5K14523	gp	
Version	Date	Modification project	Name	00 5K14521

MicroDrive
BAT010C



Cover sheet

5526,0087

Page 1
of 7

controller



mounting panel



motor + gearing



light barrier transmitter



Option

fixing bracket
BAT010C

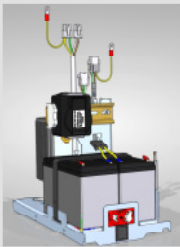

loops



Option

light barrier receiver



Option

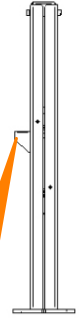
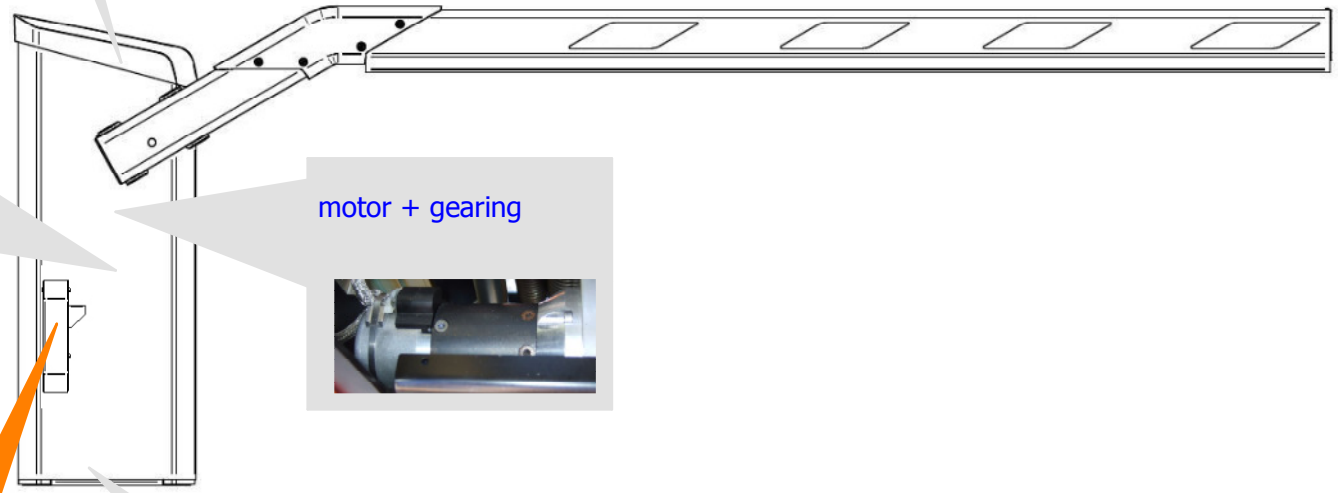

				15.08.2014
02	03.07.15	5K15503	gp	gp
01	23.09.14	5K14523	gp	
Version	Date	Modification project	Name	00 5K14521

MicroDrive
BAT010C



5526,0087

mounting panel 1

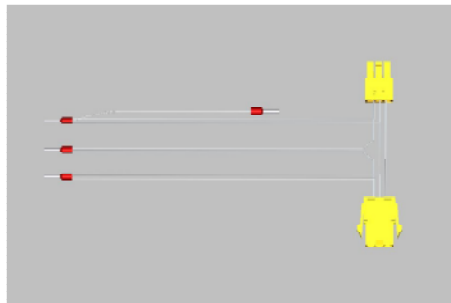
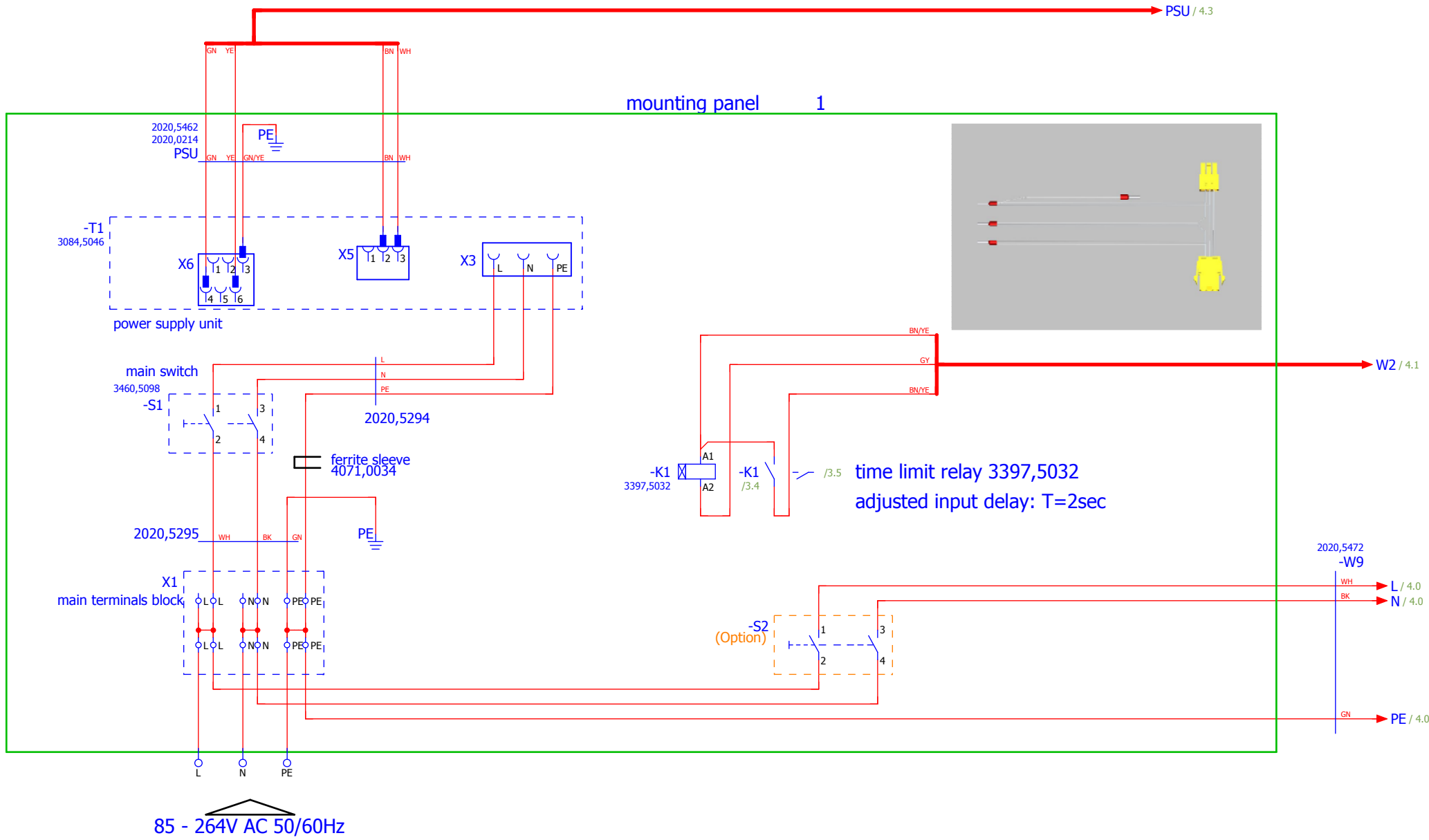

				15.08.2014
02	03.07.15	5K15503	gp	gp
01	23.09.14	5K14523	gp	
Version	Date	Modification project	Name	00 5K14521

MicroDrive
BAT010C



mounting panel

5526,0087

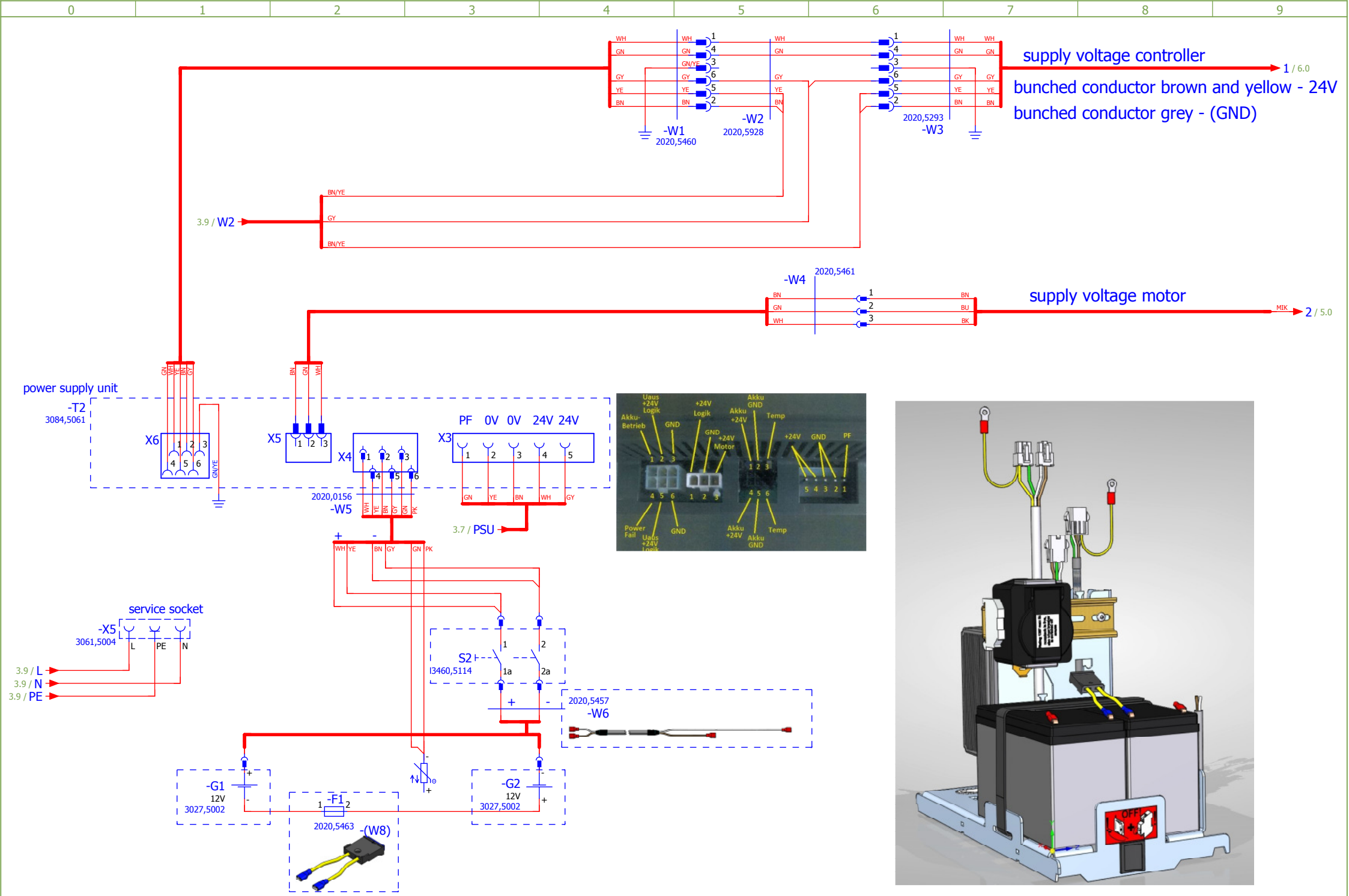

02	03.07.15	5K15503	gp	gp	15.08.2014	MicroDrive BAT010C	MAGNETIC AUTOCONTROL	Netzteil, BAT010C fixing bracket	5526,0087	Page 4 of 7
01	23.09.14	5K14523	gp	gp						
Version	Date	Modification project	Name	00 5K14521						



				15.08.2014
02	03.07.15	5K15503	gp	gp
01	23.09.14	5K14523	gp	
Version	Date	Modification project	Name	00 5K14521

MicroDrive
BAT010C



Motor

		=
		+
	5526,0087	Page 5
		of 7

Voltage supply cable MGC

motor Interface cable

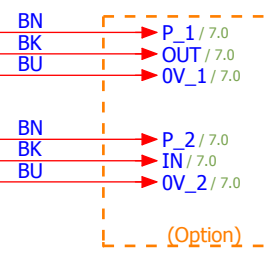

barrier controller MGC

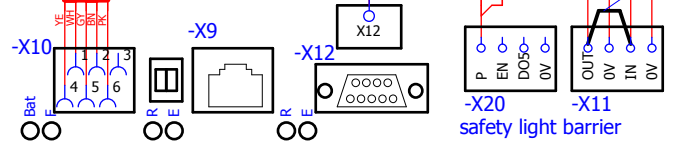

if no safety light barrier is connected, place jumper

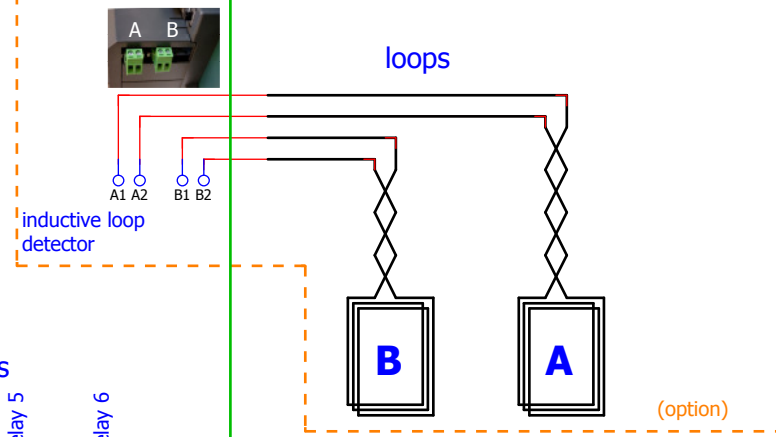

Transistor Outputs

Relay Outputs

Inputs

24V DC

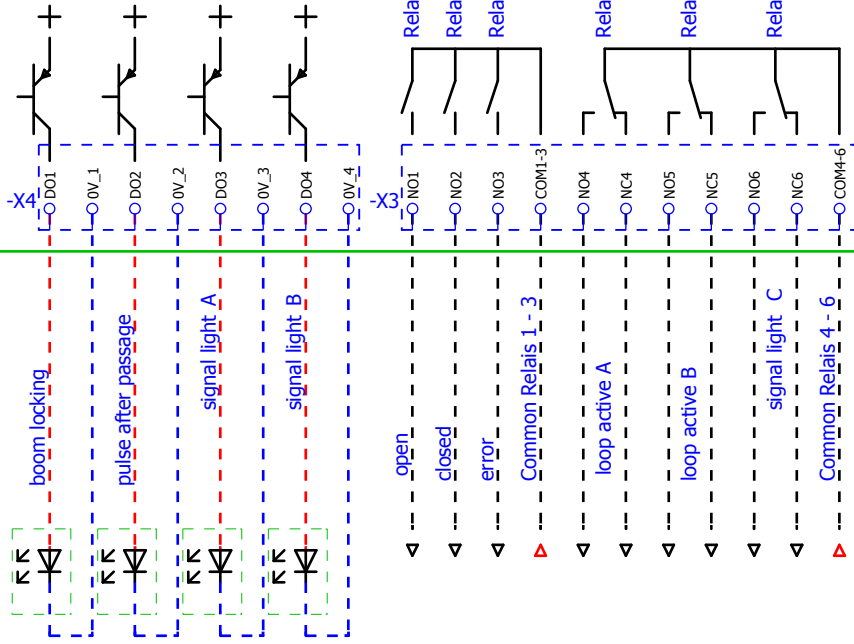
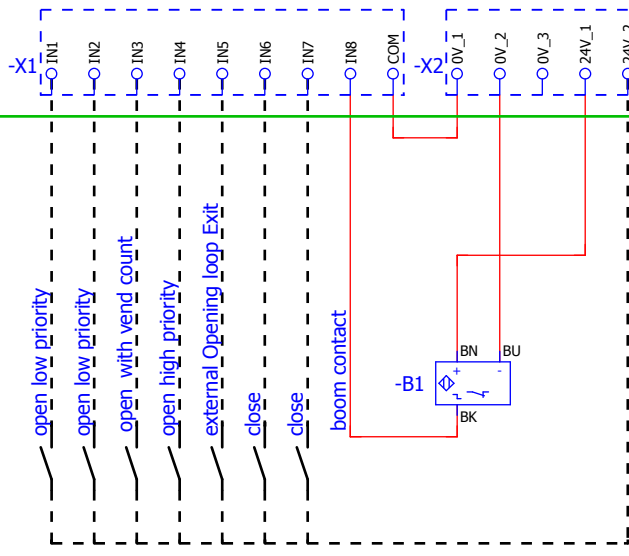

Version	Date	Modification project	Name	00 5K14521
02	03.07.15	5K15503	gp	gp
01	23.09.14	5K14523	gp	

MicroDrive
 BAT010C



barrier controller MGC
 input/output

5526,0087

6.9 / P_1 → BN
 6.9 / OUT → BK
 6.9 / OV_1 → BU

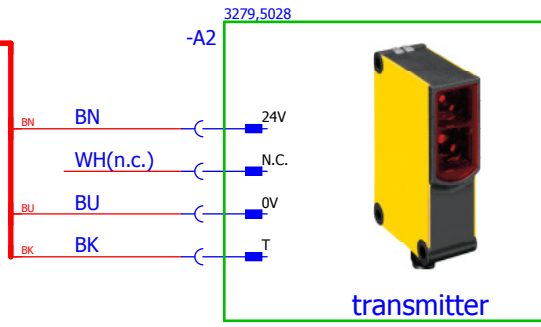

6.9 / P_2 → BN
 6.9 / IN → BK
 6.9 / OV_2 → BU

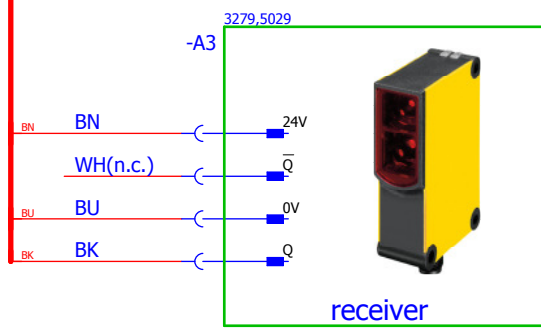

(option)

				15.08.2014
02	03.07.15	5K15503	gp	gp
01	23.09.14	5K14523	gp	
Version	Date	Modification project	Name	00 5K14521

MicroDrive
 BAT010C



safety-light barriers Option
 LS01

5526,0087